

éCO-extraction

transfrontalière

[www.eet-alcotra.eu]



a l c o t r a



DSTF

Dipartimento di Scienza
e Tecnologia del Farmaco
UNIVERSITÀ DI TORINO

Comparaison des procédés d'extraction conventionnels, micro-ondes,
ultra-sons, avec différentes matrices végétales. Essais du laboratoire sur
pilotes industriels avec études de cas

PART 2

Giancarlo Cravotto*, Arianna Binello, Stefano Mantegna, Lavinia Alexandru

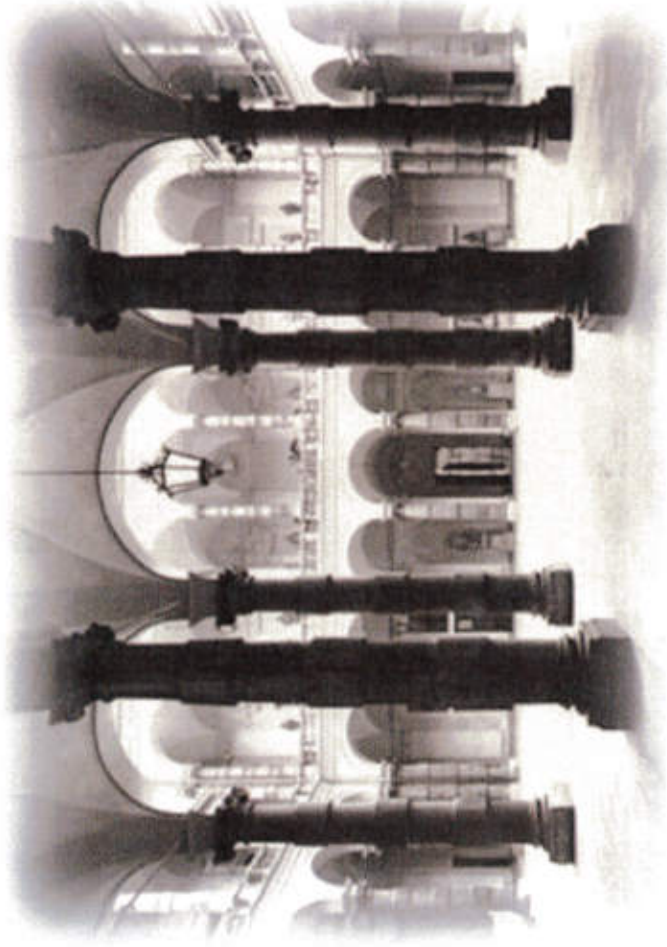

ALMA
UNIVERSITAS TAURINENSIS



University of Turin founded in 1404 by
Prince Ludovico of Savoia under the
auspices of Pope Benedict III and the
Emperor Sigmund



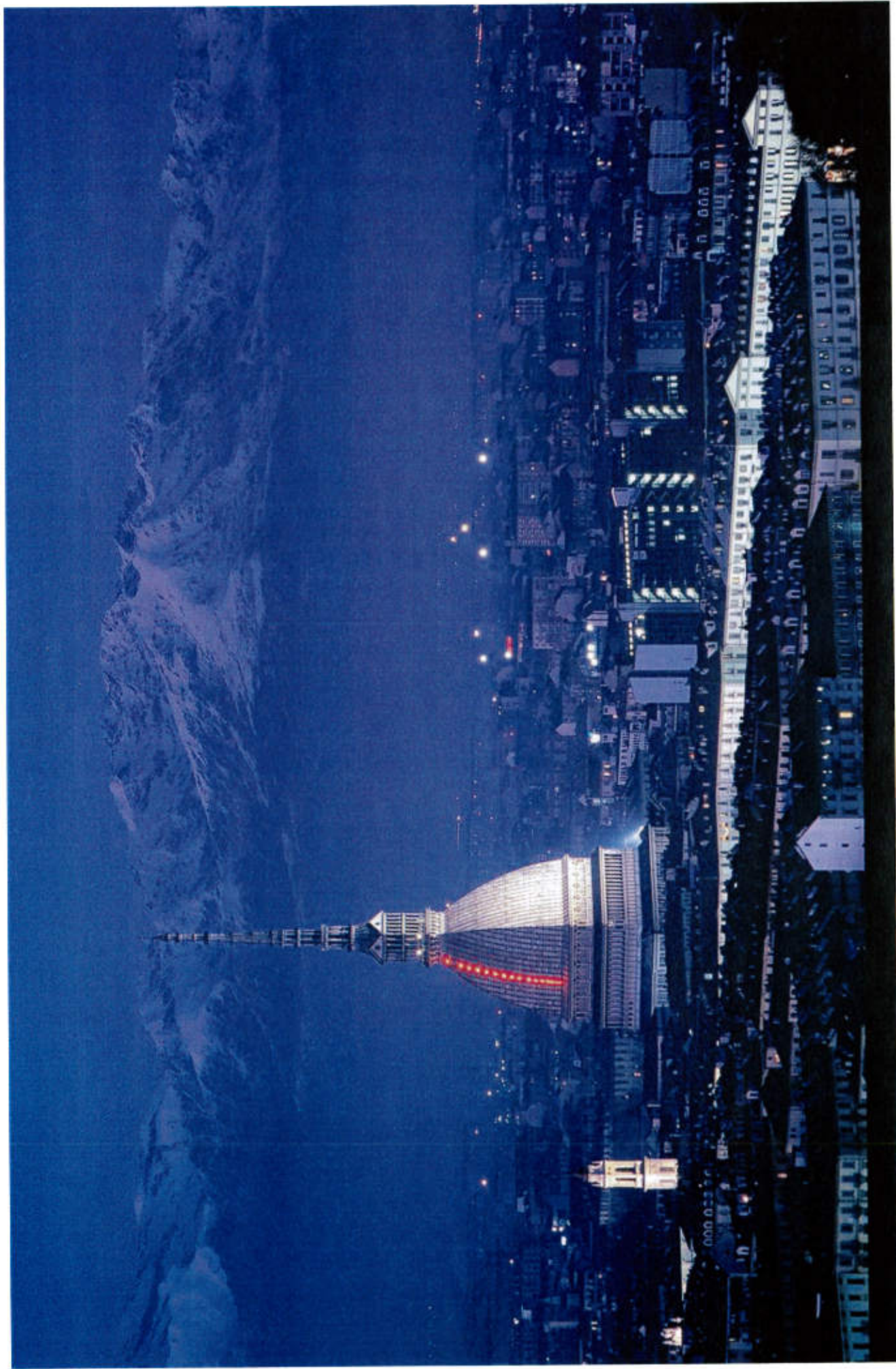

DSTF
Dipartimento di Scienza
e Tecnologia del Farmaco
UNIVERSITÀ DI TORINO



8^e Plénière France Éco-Extraction

Jeudi 24 octobre 2013
Aix-en-Provence



Jeudi 24 octobre 2013
Aix-en-Provence

 **8^e Plénière France Éco-Extraction**

Fields of application

Pharmaceutical, phytochemical, cosmetic and food industry

Partenaires

DSM Nutritional Products, Soremartec – Ferrero SpA
Group, Procemsa Farmaceutici, Martin Bauer, MB
Med, Reynaldi, Pernod-Richard Italia, Medestea Int.
and others

Equipments

Batch and flow ultrasound reactors:
multi-horns, vibrating baths etc.

Microwave ovens and reactors,
high-pressure microwave reactors,
microwave-generated hydrodistillation

Supercritical CO₂ extraction

Purification tools (ultrafiltration, combi-flash)
Analytical support: GC/MS, HPLC/MS, NMR

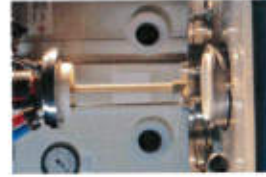

Contact

Prof. Giancarlo CRAVOTTO
Department Director
giancarlo.cravotto@unito.it

Tel +39 011670.7684
Fax +39 011670.7687

Eco-extracts vs. traditional extracts



Mentha piperita L.; *Mentha spicata* L.



Actinidia deliciosa L.



Corylus avellana L.



Vitis vinifera L.



Lavandula angustifolia Mill.,
Origanum vulgare L. ssp. *hirtum* (Link),
Ocimum basilicum L.,
Salvia officinalis subsp. *officinalis*,
Salvia officinalis 'Extrakta',
Salvia officinalis subsp. *lavandulifolia*,
Salvia sclarea L..

Microwave-assisted extraction (MAE)

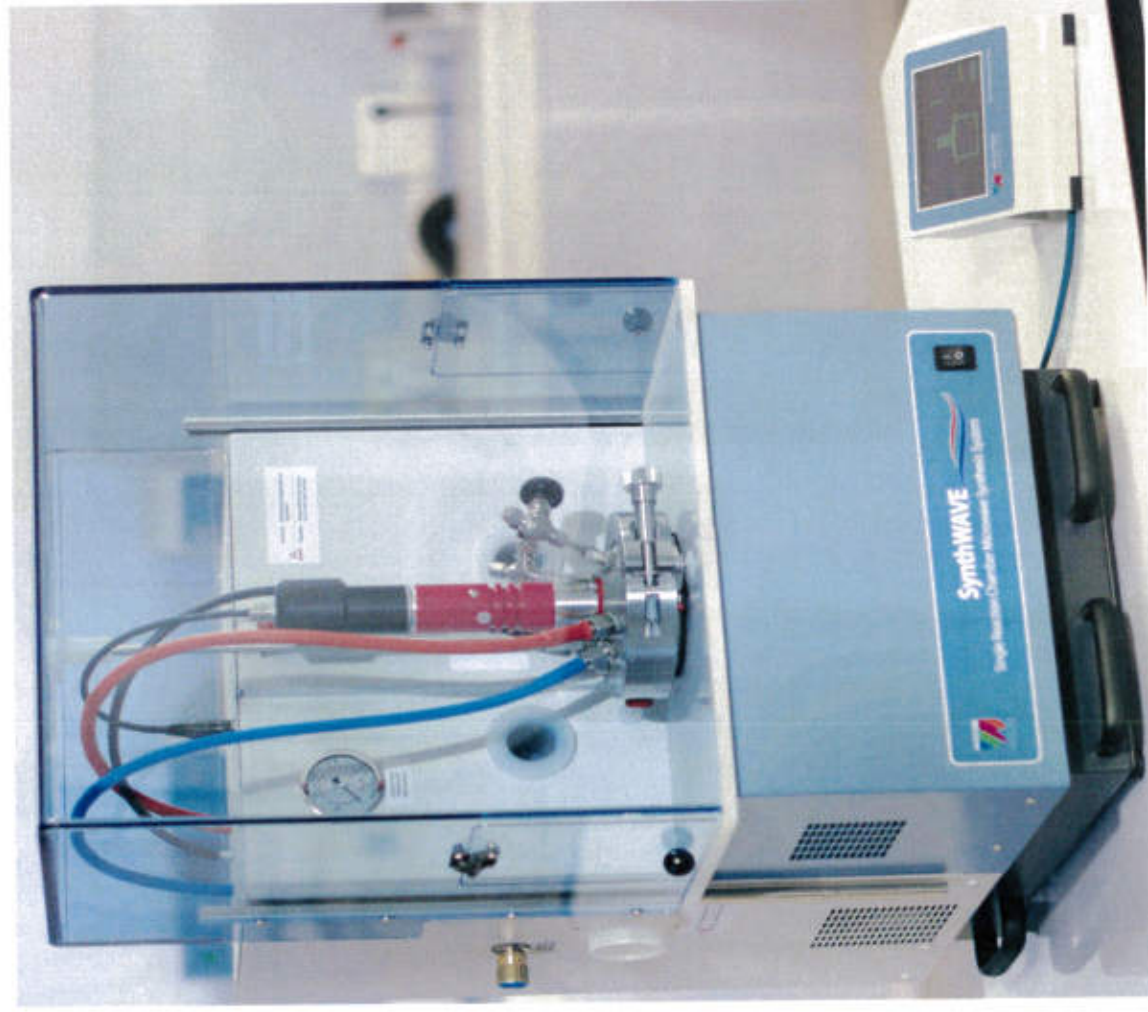

SYNTHWAVE (Milestone)

HIGH POWER DENSITY: **1.5 kW** / 1 L

HIGH TEMPERATURE: **300 °C**

HIGH PRESSURE: **200 bar** (3 gas inlets)

FAST HEATING & COOLING (chiller)



Microwave-assisted extraction (MAE)

NEOS-GR (Milestone)

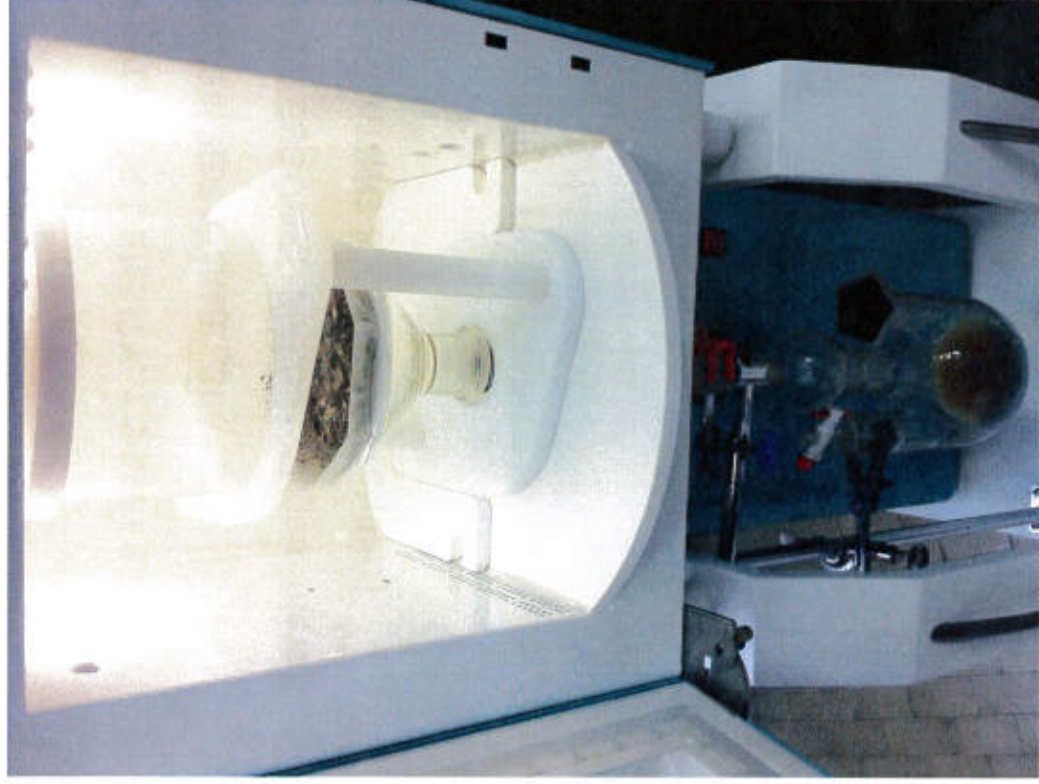

MW-assisted
hydrodistillation



Microwave-assisted extraction (MAE)

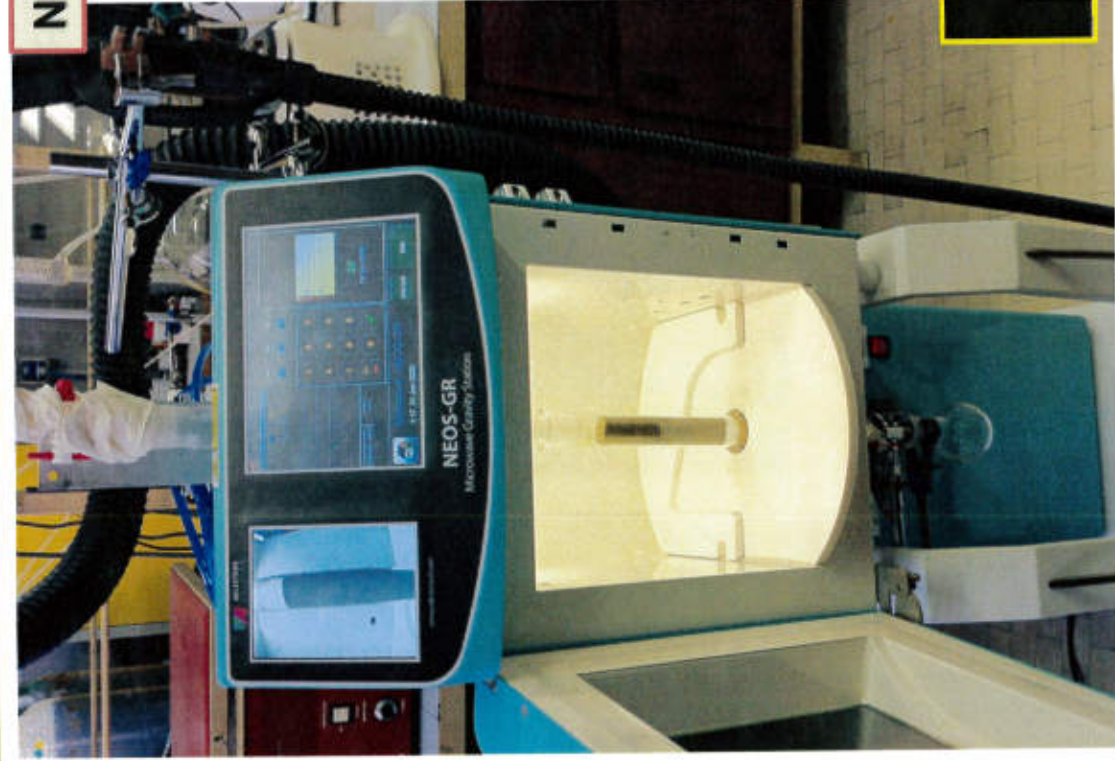

NEOS-GR (Milestone)

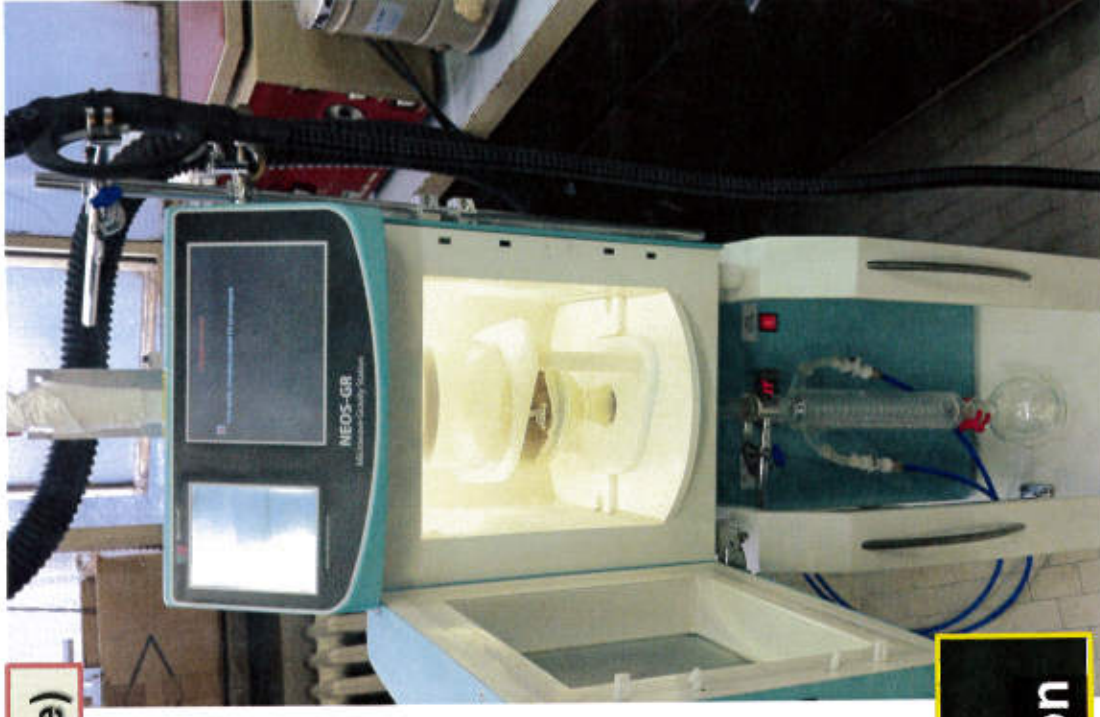

MW-assisted
hydrodistillation

Microwave-assisted extraction (MAE)

FILTRATION

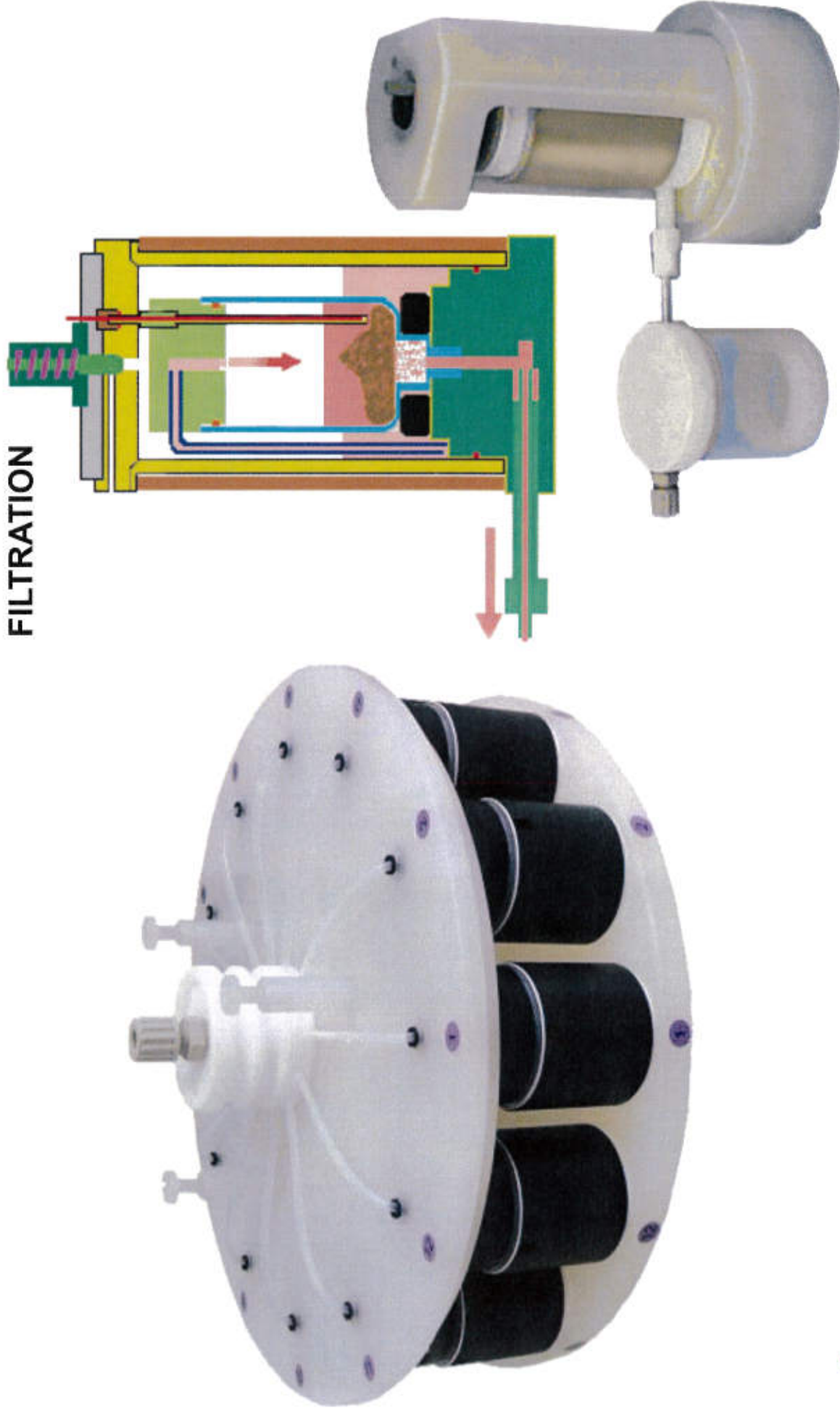

Microwave-assisted extraction (MAE)



ROTOSYNTH (Milestone)

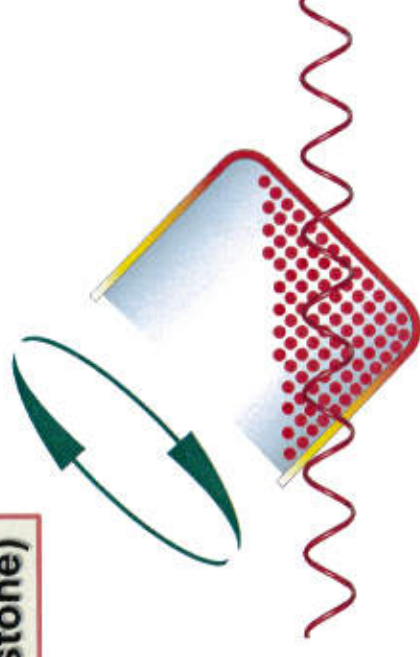

Microwave-assisted extraction (MAE)



Microwave-assisted extraction (MAE)

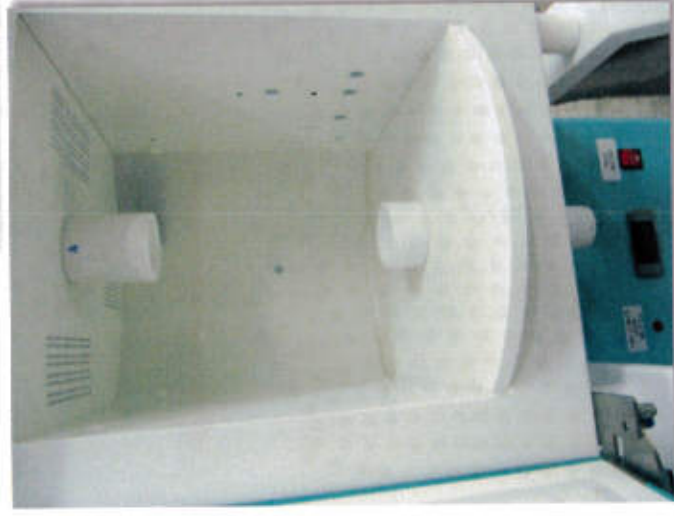
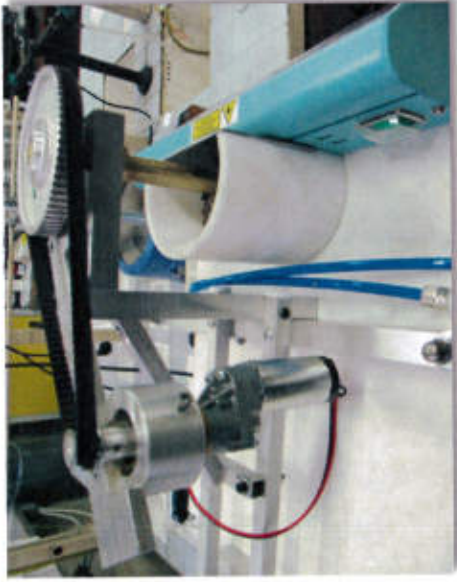

Ultrasound-assisted extraction (UAE)

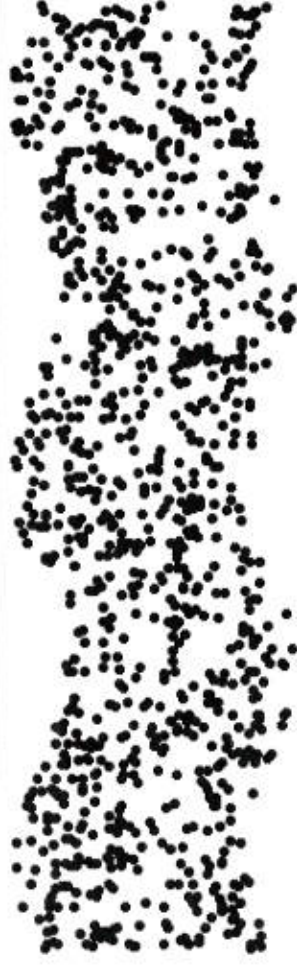
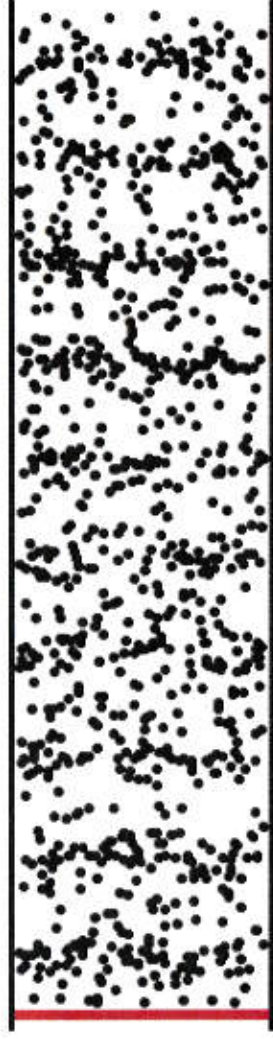

WAVE IN A SOLID

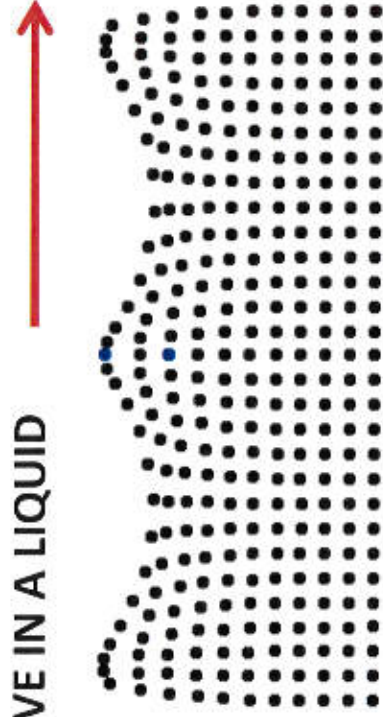

WAVE IN A LIQUID

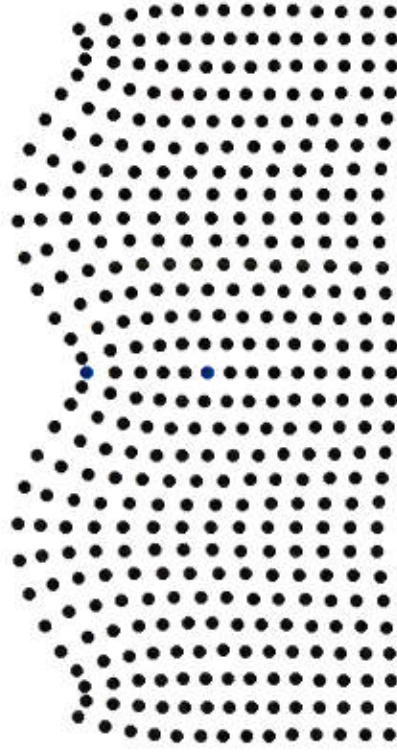

WAVE IN A SOLID

Ultrasound-assisted extraction (UAE)



100 kHz

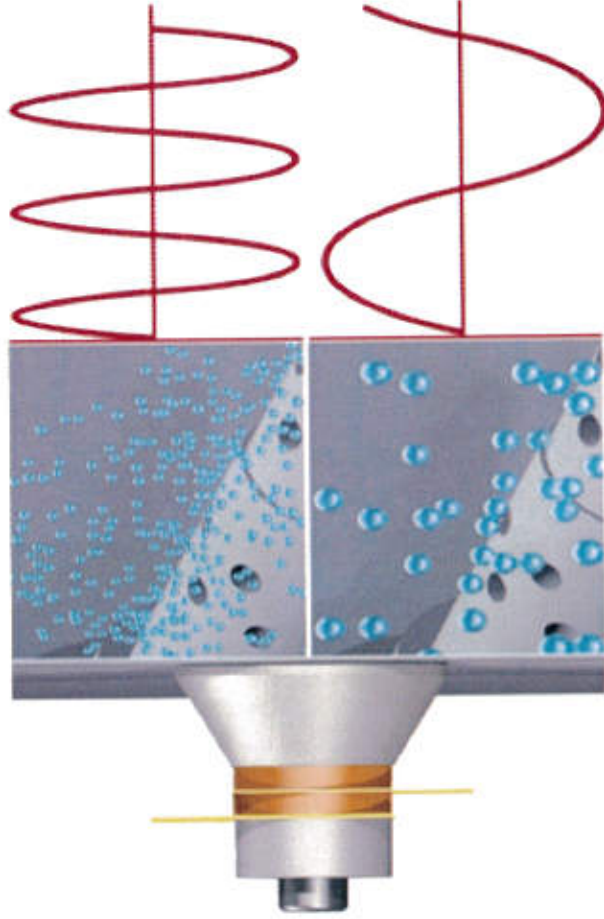

20 kHz

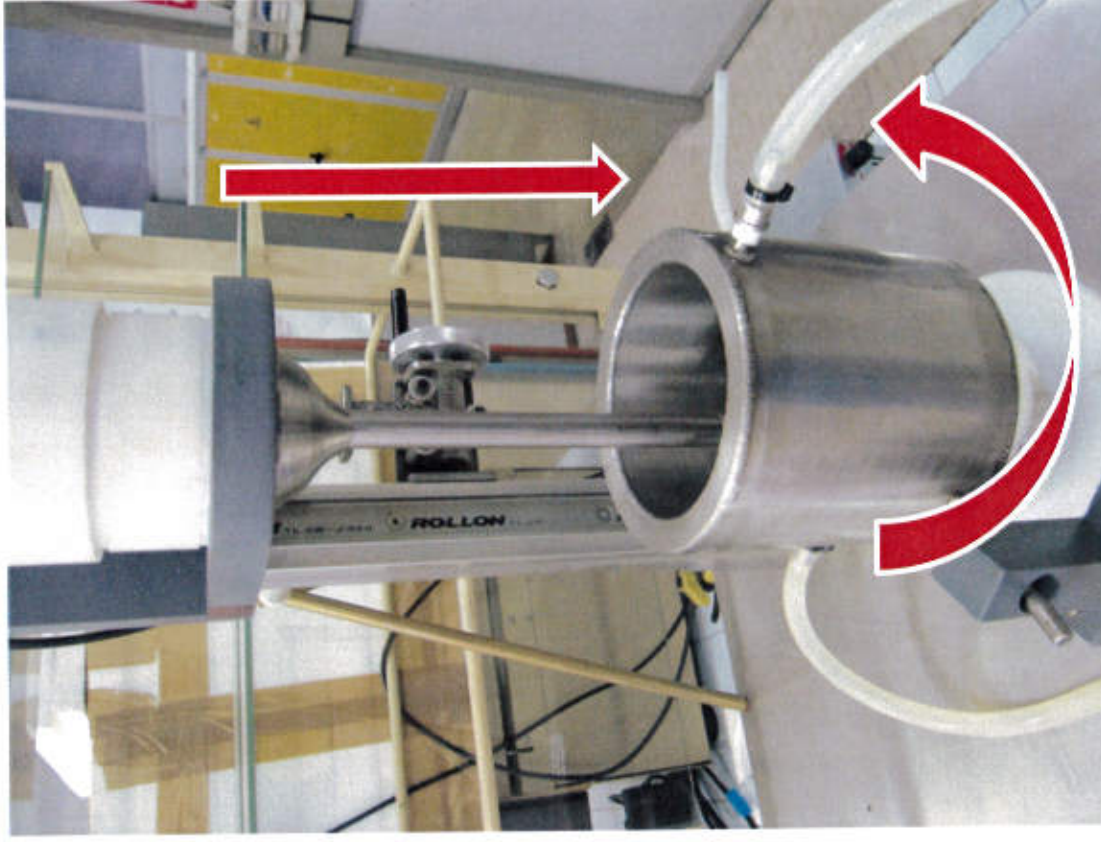

Ultrasound-assisted extraction (UAE)

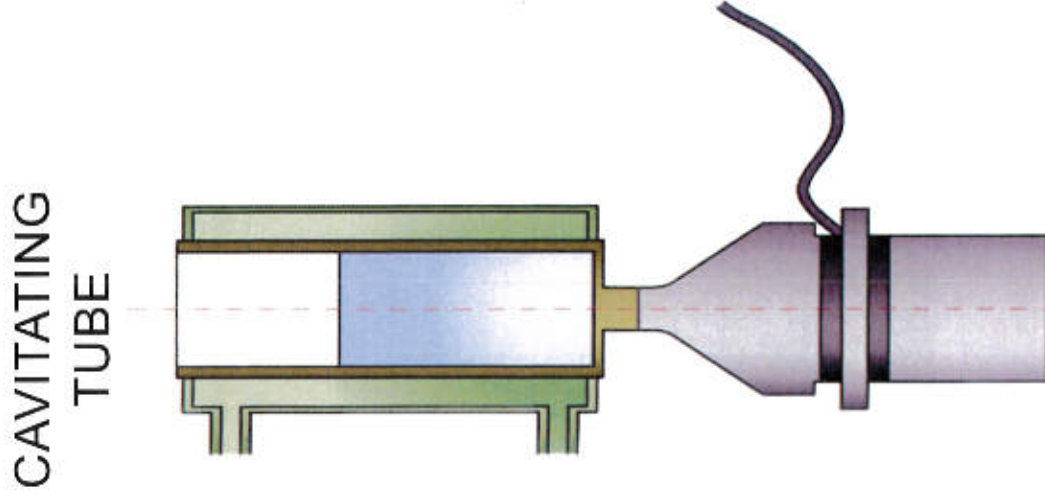
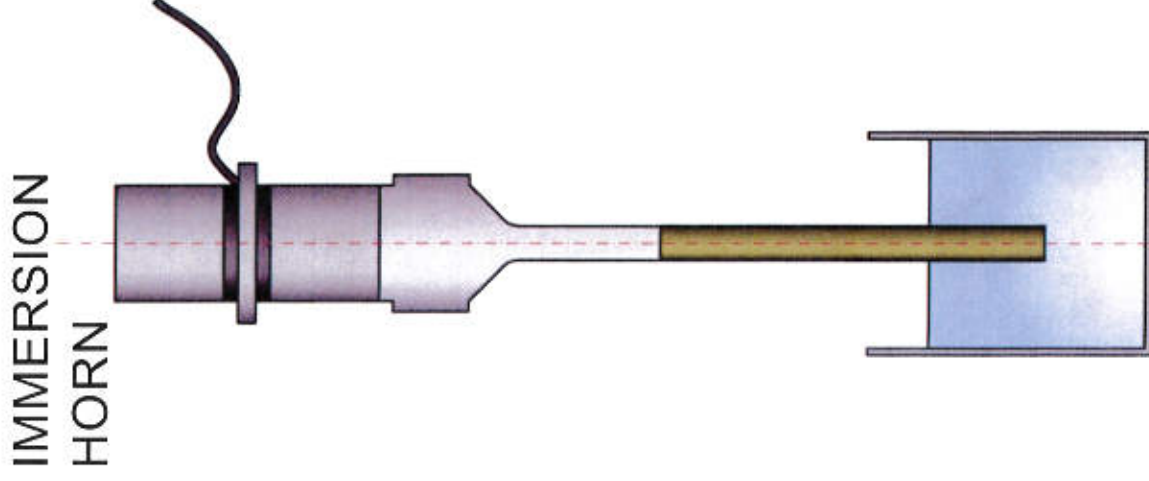
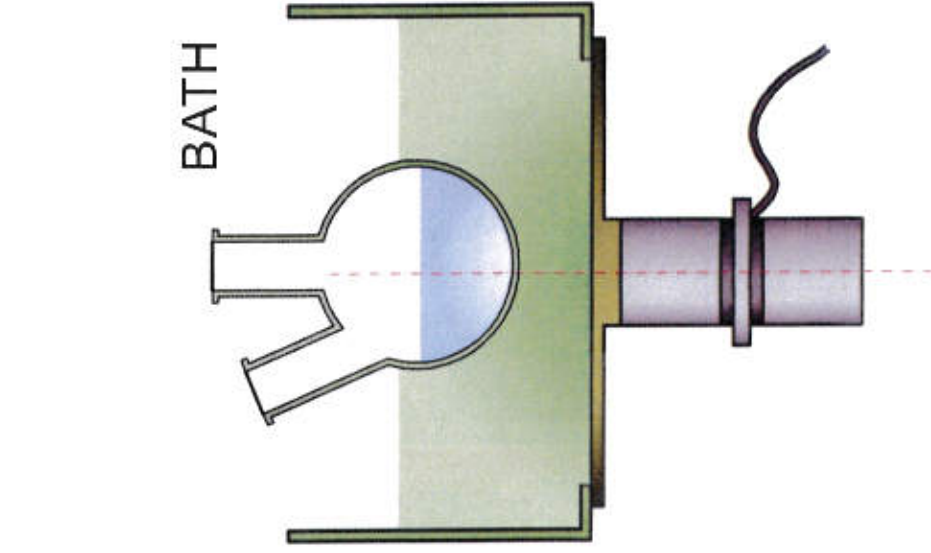

Ultrasound-assisted extraction (UAE)

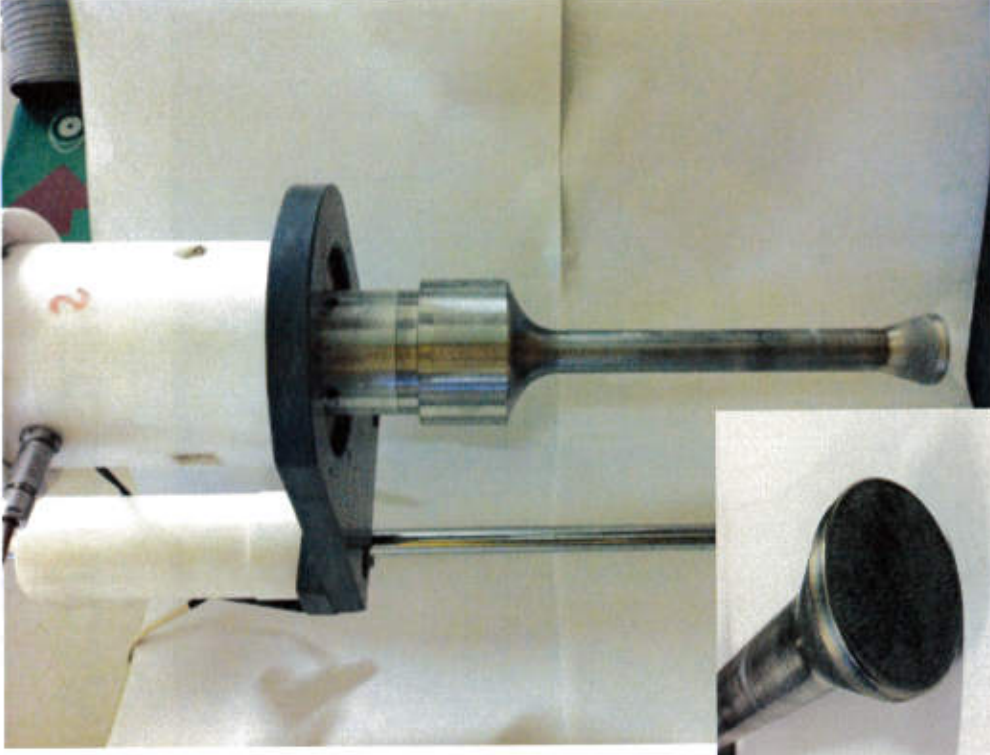
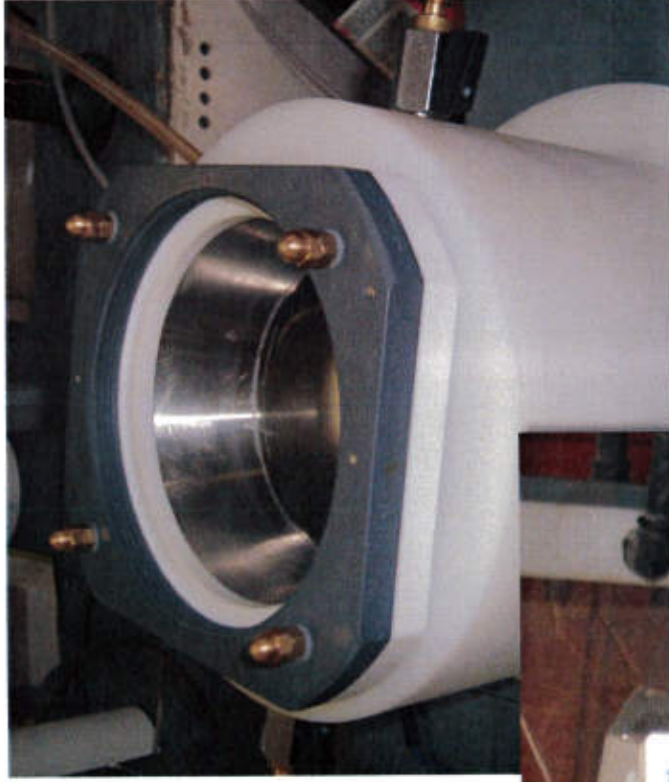
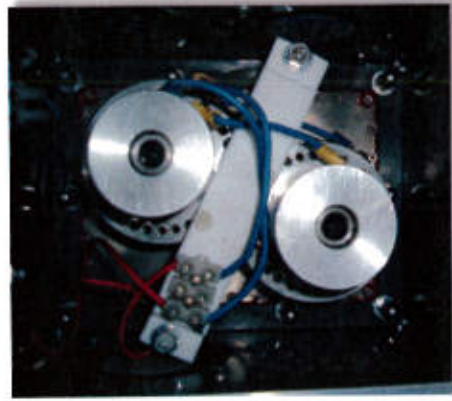

Ultrasound-assisted extraction (UAE)

MODIFIED ATMOSPHERE

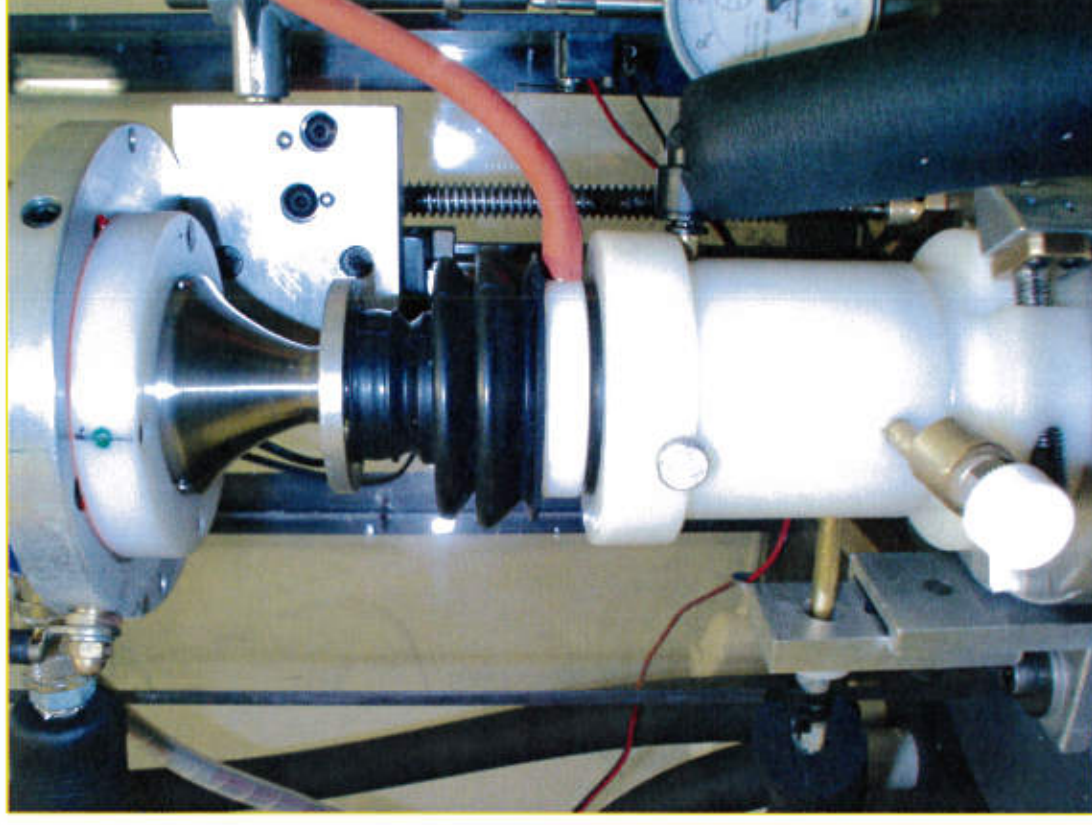
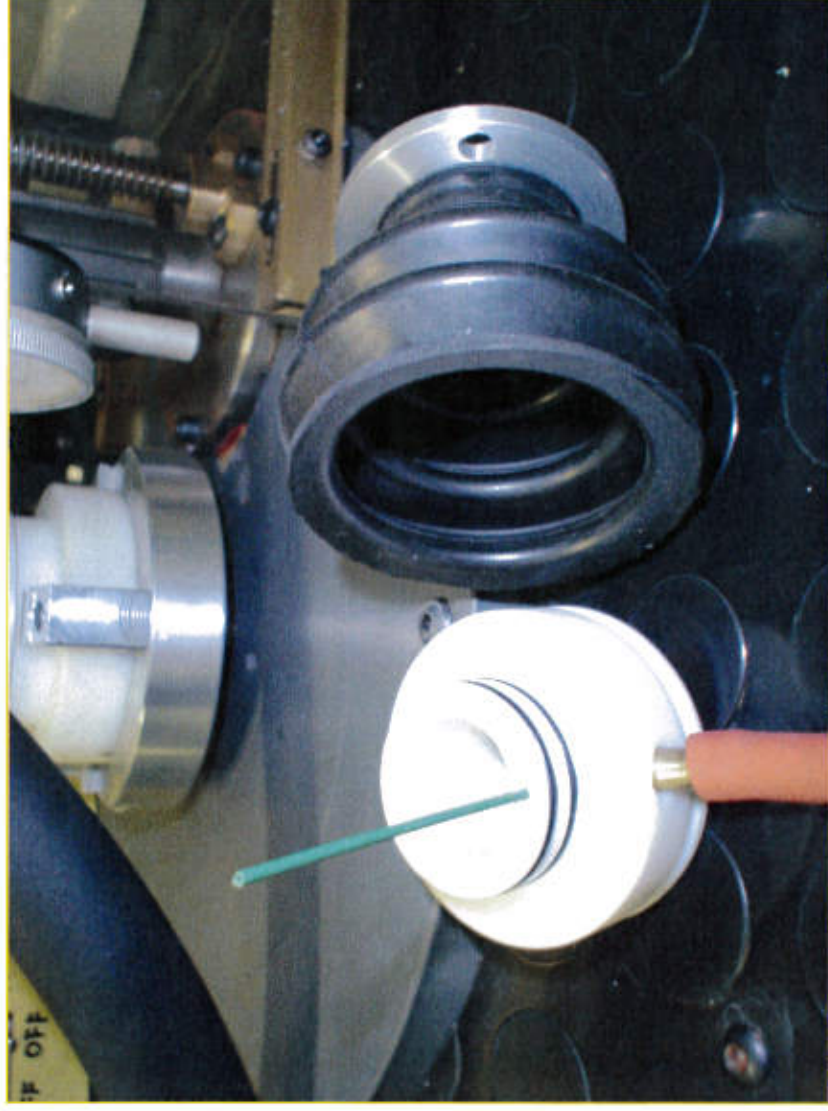

Ultrasound-assisted extraction (UAE)

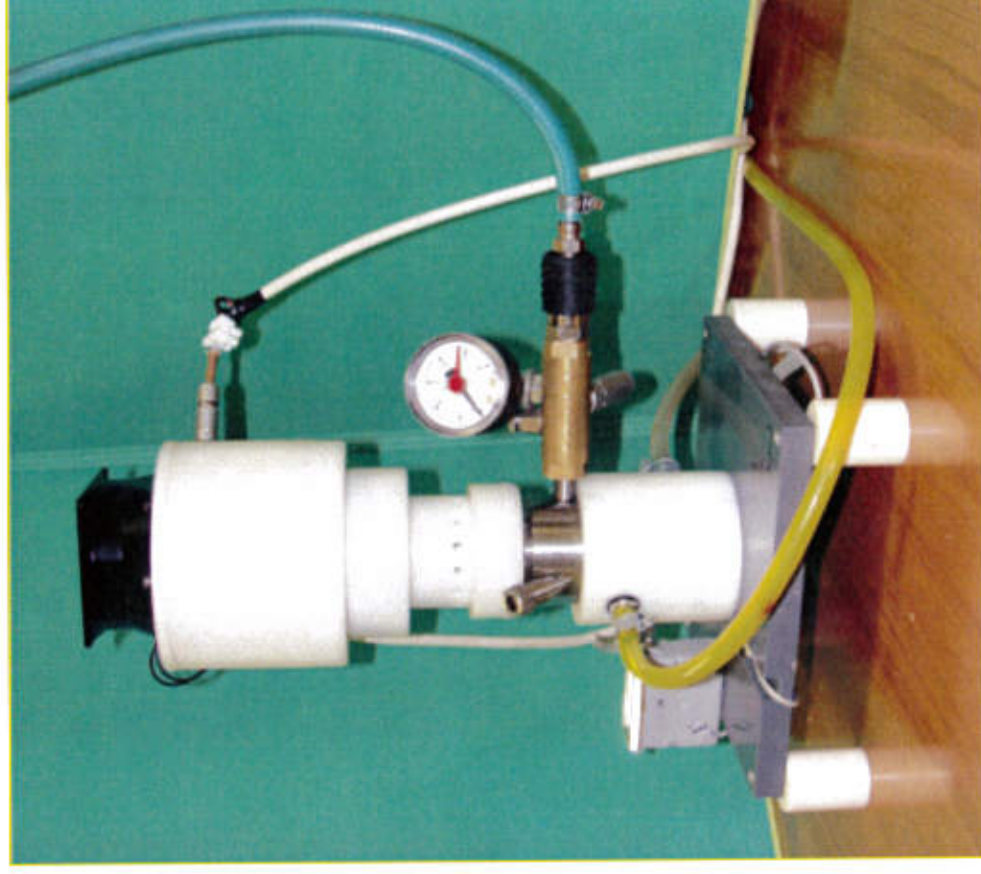
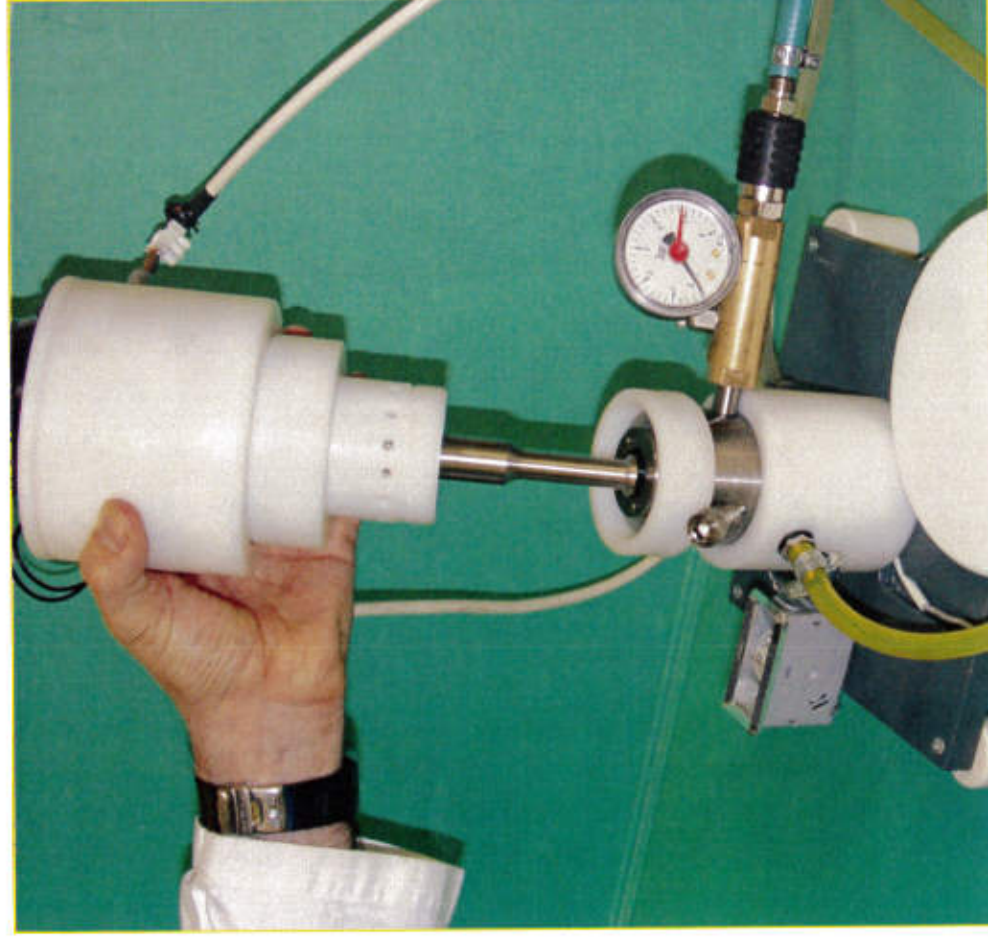

Ultrasound-assisted extraction (UAE)

